

2400 BOUNDARY ROAD
 BURNABY B.C. V5M3Z3
 CANADA

T: 604.482.2000
 F: 604.482.2007

SOUND STAGE: 3

FEATURES

- 10,979 sq.ft. [1020m sq.]
- Soundproof
- Elephant Doors
- 1800amps 120/208v
- GRID = 7,500 Total lbs./Truss
- Reverb. Time = 1 sec @500hz

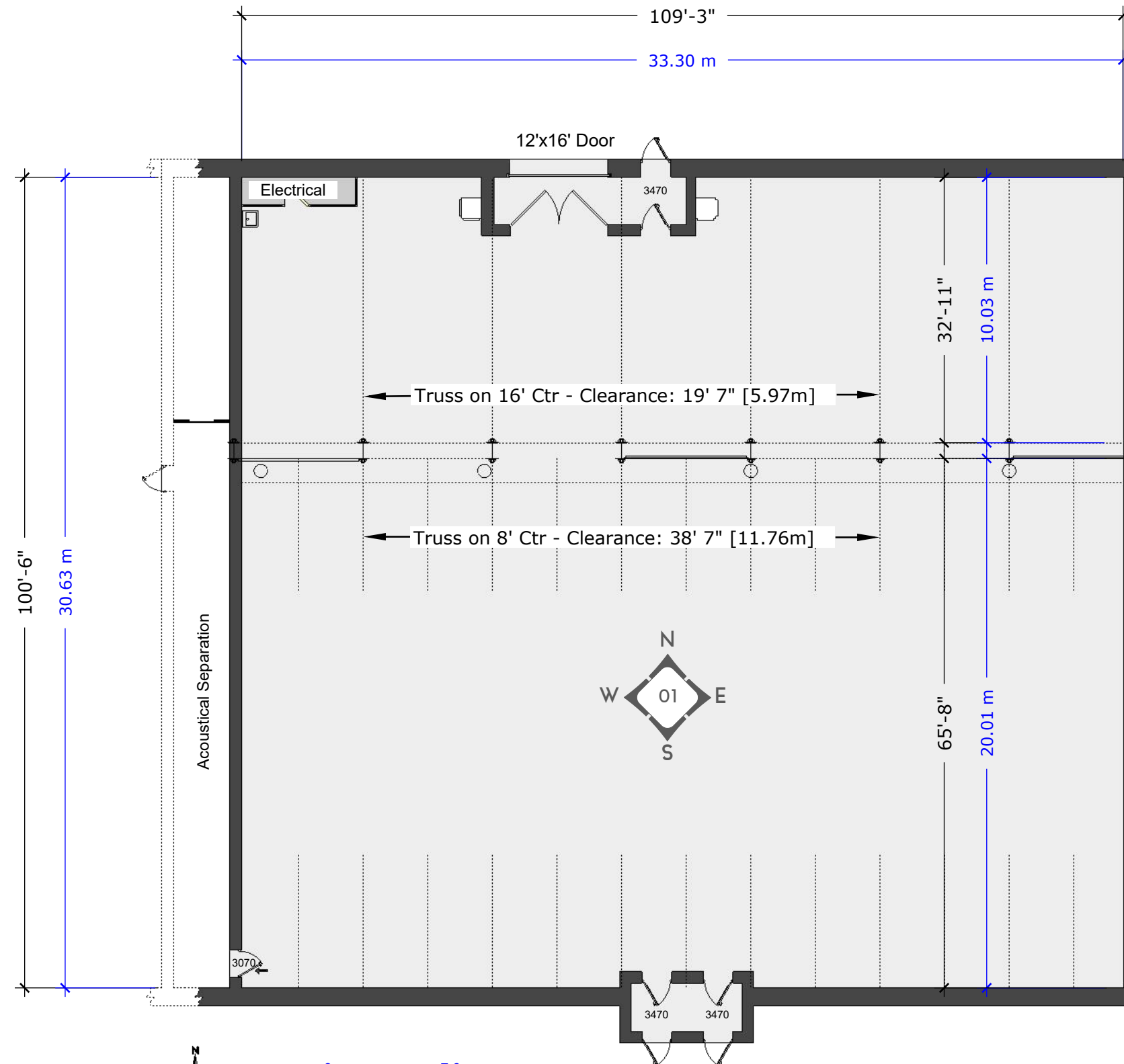

S3

STAGE 3 - PLAN

scale: 1/16" = 1' [1:192]

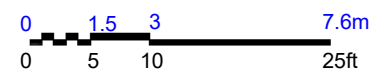

SITE LEGEND

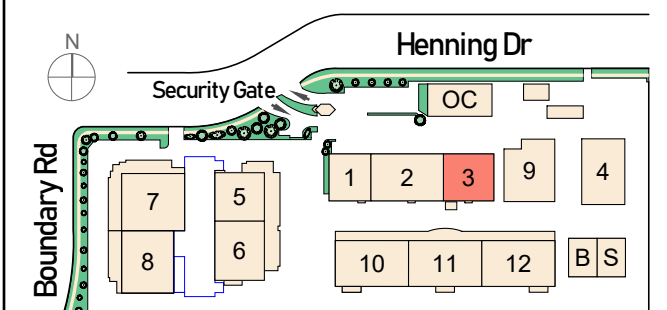

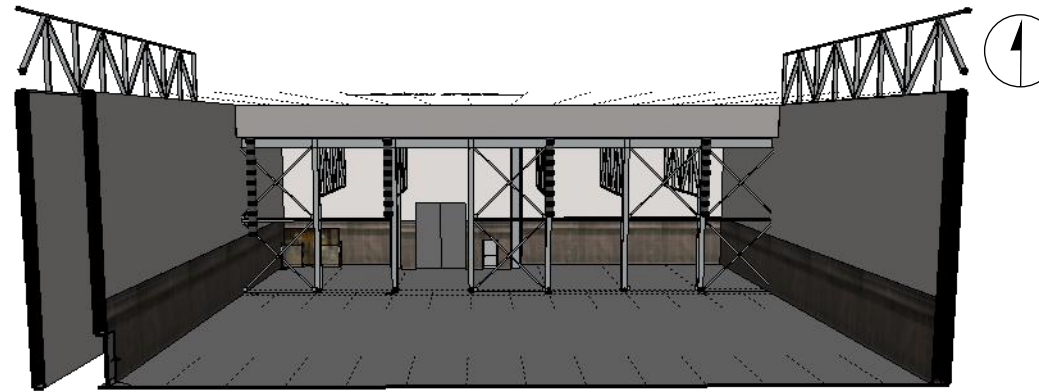
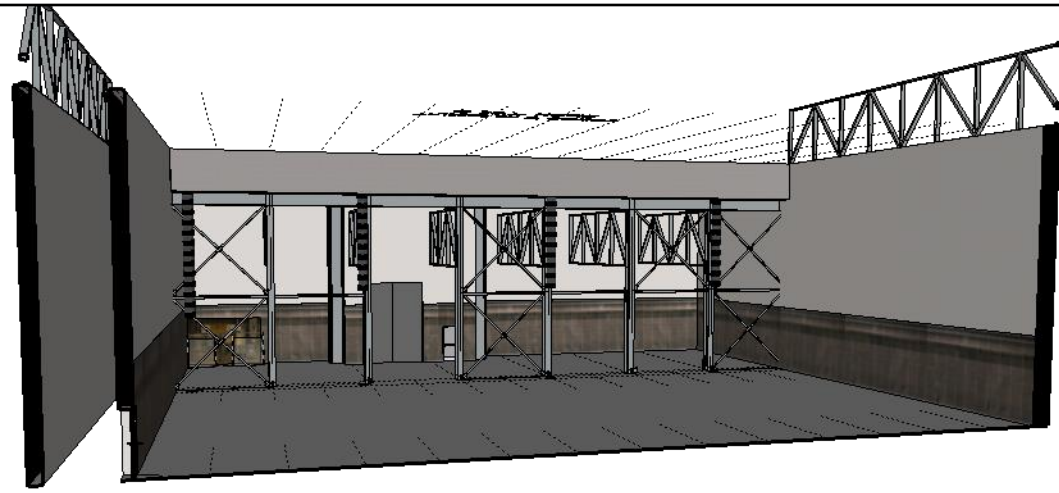

2400 BOUNDARY ROAD
 BURNABY B.C. V5M3Z3
 CANADA

T: 604.482.2000
 F: 604.482.2007

SOUND STAGE: 3

FEATURES

- 10,979 sq.ft. [1020m sq.]
- Soundproof
- Elephant Doors
- 1800amps 120/208v
- GRID = 7,500 Total lbs./Truss
- Reverb. Time = 1 sec @500hz

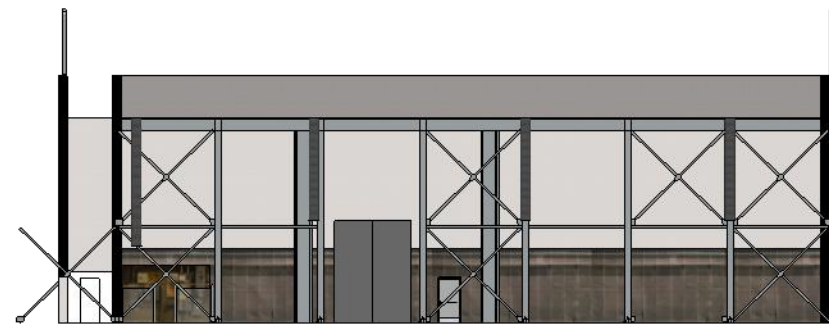

N ELEV NORTH
 scale: 1" = 30' [1:360]

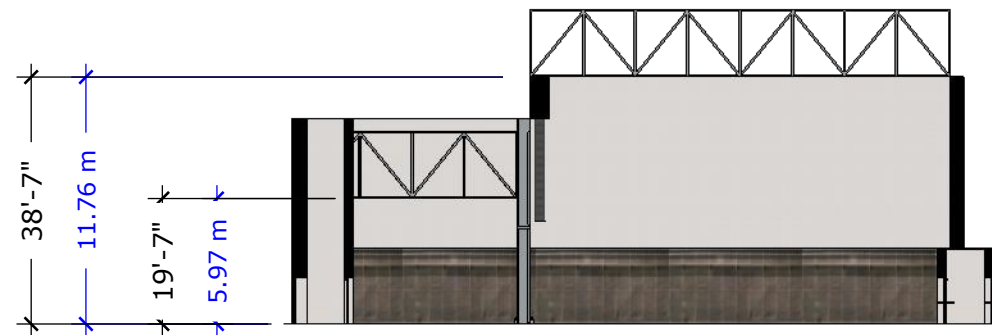

E ELEV EAST
 scale: 1" = 30' [1:360]

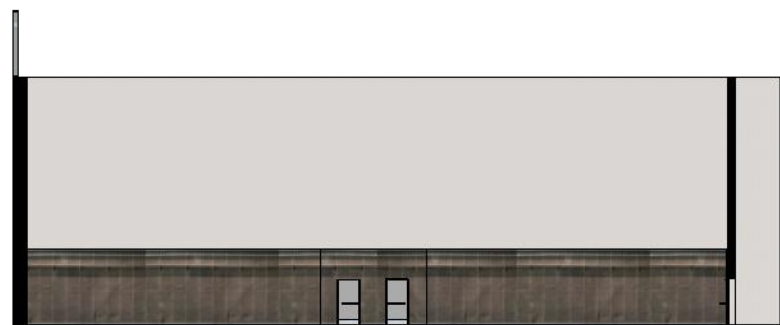

S ELEV SOUTH
 scale: 1" = 30' [1:360]

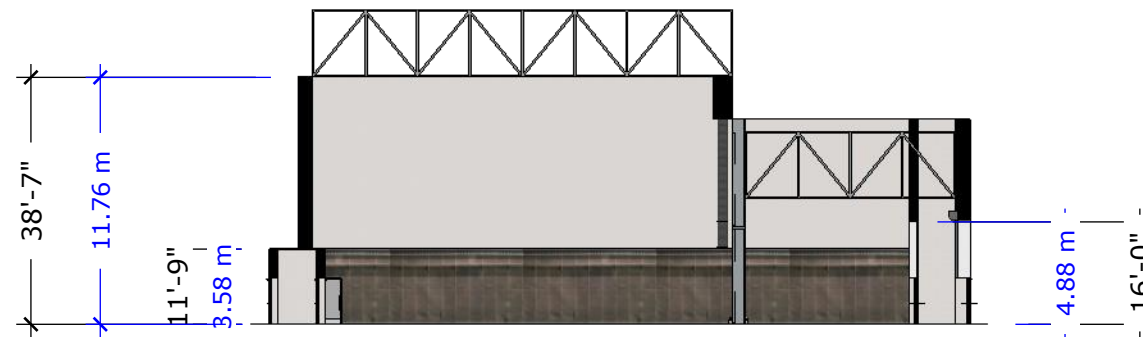

W ELEV WEST
 scale: 1" = 30' [1:360]

SITE LEGEND

